

## Specifications

Current rating: 7A AC,DC  
 Voltage rating: 250V AC,DC  
 Temperature range: -25°C ~ +85°C  
 Contact resistance: 20mΩ Max.  
 Insulation resistance: 1000MΩ Min.  
 Withstanding voltage: 1500V AC/minute  
 \*Contact E.N for Details\*

## Standards



E473953

## Assembly layout

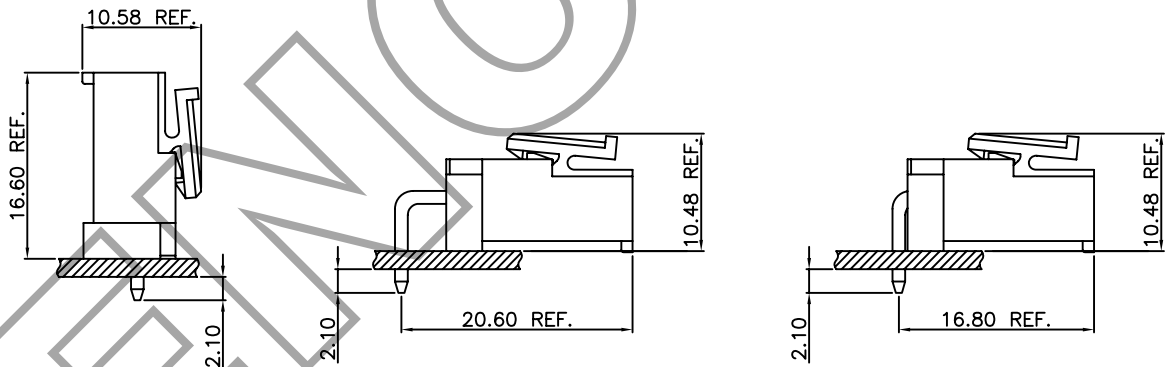

## Ordering code

A7923 WR A -NP  
 ① ② ③ ④

- ① Series No.
- ② Connector type: WV=Vertical, WR=Right angle
- ③ Blank=Normal type  
A=A type
- ④ No. of circuits

## A7923WV — 7.92mm pitch 180° Wafer

### Reference Informations:

\*Material: Pin: Phosphor Bronze/Tin-plated  
Wafer: Nylon66, UL94V-0

\*Mates with E.N A3963 series Housing

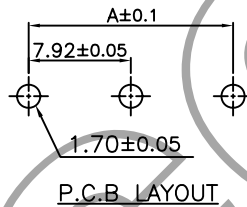
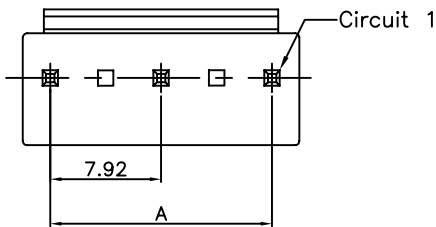
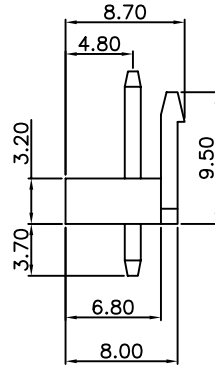
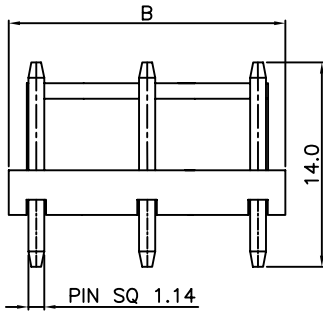

Ordering Information & Dimensions

PART NO.	Dimensions	
	A	B
A7923WV-02P	7.92	11.88
A7923WV-03P	15.84	19.80
A7923WV-04P	23.76	27.72
A7923WV-05P	31.68	35.64
A7923WV-06P	39.60	43.56
A7923WV-07P	47.52	51.48
A7923WV-08P	55.44	59.40

Unit: mm

## A7923WVA — 7.92mm pitch 180° Wafer

### Reference Informations:

\*Material: Pin: Phosphor Bronze/Tin-plated  
Wafer: Nylon66, UL94V-0

\*Mates with E.N A3963 series Housing

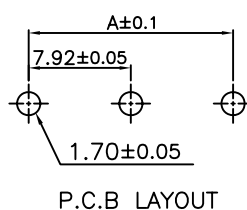
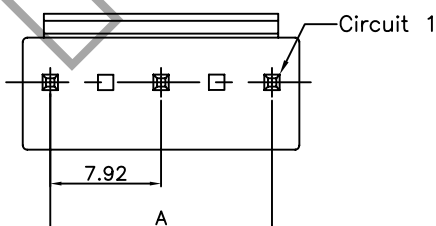
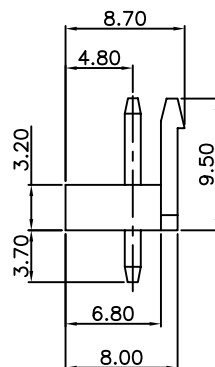
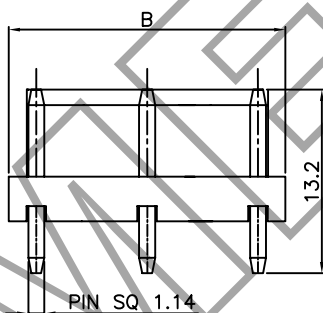

Ordering Information & Dimensions

PART NO.	Dimensions	
	A	B
A7923WVA-02P	7.92	11.88
A7923WVA-03P	15.84	19.80
A7923WVA-04P	23.76	27.72
A7923WVA-05P	31.68	35.64
A7923WVA-06P	39.60	43.56
A7923WVA-07P	47.52	51.48
A7923WVA-08P	55.44	59.40

Unit: mm

## A7923WVR — 7.92mm pitch 180° Wafer

### Reference Informations:

- \*Material: Pin: Phosphor Bronze/Tin-plated  
Wafer:Nylon66,UL94V-0
- \*Mates with E.N A3963 series Housing

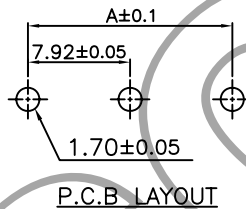
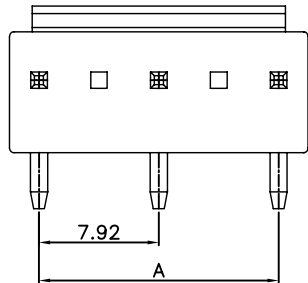
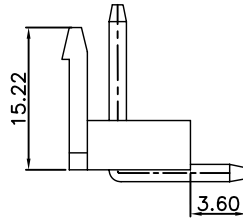
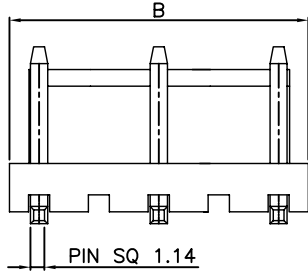
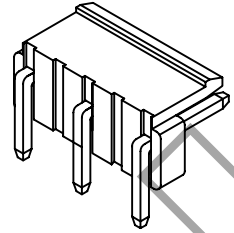

### Ordering Information & Dimensions

PART NO.	Dimensions	
	A	B
A7923WVR-02P	7.92	11.88
A7923WVR-03P	15.84	19.80
A7923WVR-04P	23.76	27.72
A7923WVR-05P	31.68	35.64
A7923WVR-06P	39.60	43.56
A7923WVR-07P	47.52	51.48
A7923WVR-08P	55.44	59.40

Unit: mm

## A7923WR — 7.92mm pitch 90° Wafer

### Reference Informations:

- \*Material: Pin: Phosphor Bronze/Tin-plated  
Wafer:Nylon66,UL94V-0
- \*Mates with E.N A3963 series Housing

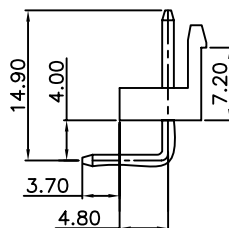
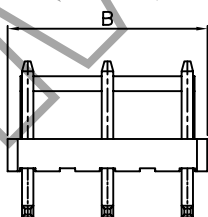
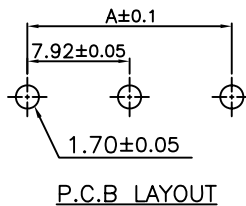
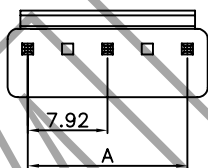
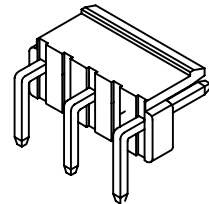

### Ordering Information & Dimensions

PART NO.	Dimensions	
	A	B
A7923WR-02P	7.92	11.88
A7923WR-03P	15.84	19.80
A7923WR-04P	23.76	27.72
A7923WR-05P	31.68	35.64
A7923WR-06P	39.60	43.56
A7923WR-07P	47.52	51.48
A7923WR-08P	55.44	59.40

Unit: mm