

Specifications

Current rating: 1A AC,DC
 Voltage rating: 125V AC,DC
 Temperature range: -25°C ~ +85°C
 Contact resistance: 20mΩ Max.
 Insulation resistance: 100MΩ Min.
 Withstanding voltage: 500V AC/minute
 Contact E.N for Details

Standards



Assembly layout

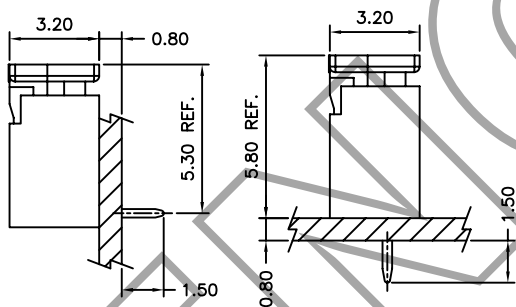

DIP TYPE

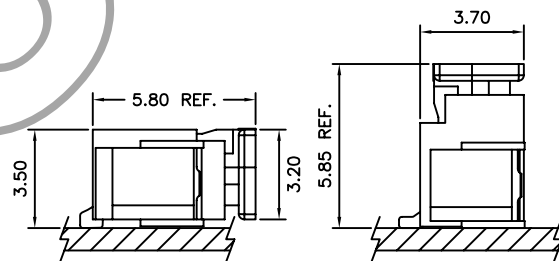

SMT TYPE

Ordering code

A1251 - T P
 ① ② ③

- ① Series No.
- ② Plating code: T=Tin-plated, G=Gold-flash
- ③ Material: P=Phosphor bronze

A1251 WR A -S - NP
 ① ② ③ ④ ⑤

- ① Series No.
- ② Connector type: WV=Vertical, WR=Right angle
- ③ Blank=Normal type
A=A type
- ④ Mounting type: Blank=Through hole
-S=SMT
- ⑤ No. of circuits

A1251 H - NP
 ① ② ③

- ① Series No.
- ② H=Housing
- ③ No. of circuits

A1251-T — 1.25mm pitch Crimp Terminal

Reference Informations:

*Mates with E.N A1251 series Housing

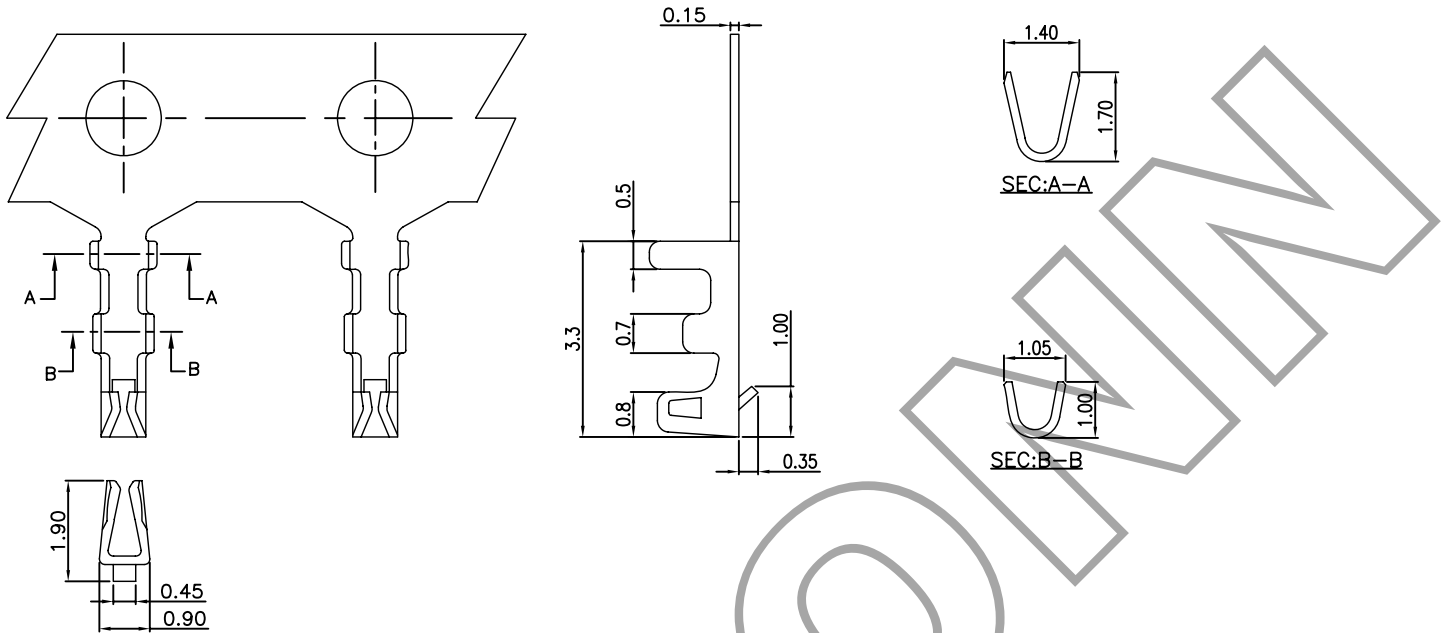

Ordering Information & Specifications

Unit: mm

Part No	Wire Range	Insulation O.D.	Material	Finish	Qty/reel
A1251-TP	AWG#28-#32	1.00mm(max)	Phosphor Bronze	Tin-plated	12,000pcs
A1251-PT	AWG#28-#32	1.00mm(max)	Phosphor Bronze	Tin-plated	12,000pcs

A1251H — 1.25mm pitch Housing

Reference Informations:

*Material: PA66,UL94V-0

*Suitable E.N A1251 series Terminal

*Mates with E.N A1251 series Wafer

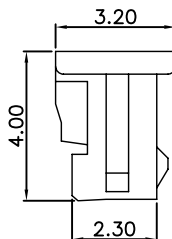
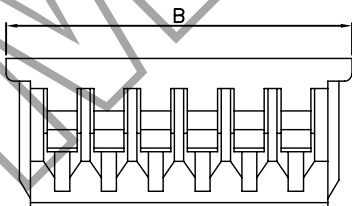
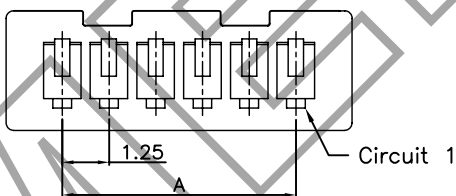
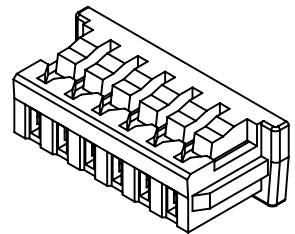

Ordering Information & Dimensions

PART NO.	Dimensions	
	A	B
A1251H-02P	1.25	4.25
A1251H-03P	2.50	5.50
A1251H-04P	3.75	6.75
A1251H-05P	5.00	8.00
A1251H-06P	6.25	9.25
A1251H-07P	7.50	10.50
A1251H-08P	8.75	11.75
A1251H-09P	10.00	13.00
A1251H-10P	11.25	14.25
A1251H-11P	12.50	15.50
A1251H-12P	13.75	16.75
A1251H-13P	15.00	18.00
A1251H-14P	16.25	19.25
A1251H-15P	17.50	20.50
A1251H-16P	18.75	21.75
A1251H-17P	20.00	23.00
A1251H-18P	21.25	24.25

Unit: mm

A1251WV — 1.25mm pitch 180° Wafer

Reference Informations:

- *Material: Pin: Phosphor Bronze/Tin-plated
Wafer: Nylon 66,UL94V-2
- *Mates with E.N A1251 series Housing

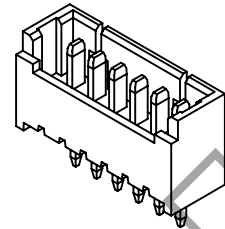
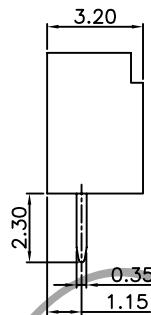
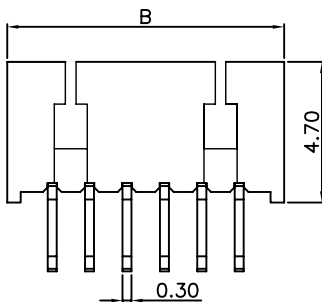
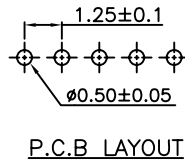
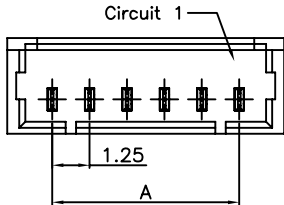

Ordering Information & Dimensions

PART NO.	Dimensions	
	A	B
A1251WV-02P	1.25	4.25
A1251WV-03P	2.50	5.50
A1251WV-04P	3.75	6.75
A1251WV-05P	5.00	8.00
A1251WV-06P	6.25	9.25
A1251WV-07P	7.50	10.50
A1251WV-08P	8.75	11.75
A1251WV-09P	10.00	13.00
A1251WV-10P	11.25	14.25
A1251WV-11P	12.50	15.50
A1251WV-12P	13.75	16.75
A1251WV-13P	15.00	18.00
A1251WV-14P	16.25	19.25
A1251WV-15P	17.50	20.50
A1251WV-16P	18.75	21.75
A1251WV-17P	20.00	23.00
A1251WV-18P	21.25	24.25

Unit: mm

A1251WR — 1.25mm pitch 90° Wafer

Reference Informations:

- *Material: Pin: Phosphor Bronze/Tin-plated
Wafer: Nylon 66,UL94V-2
- *Mates with E.N A1251 series Housing

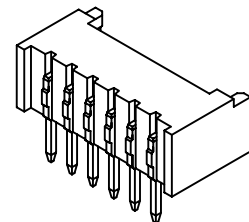
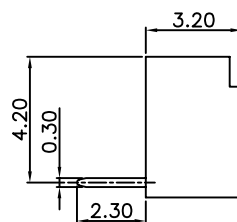
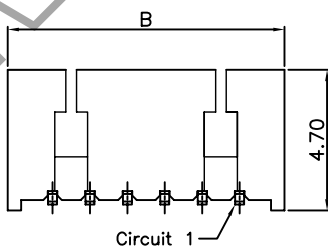
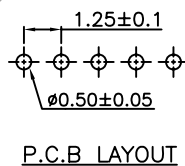
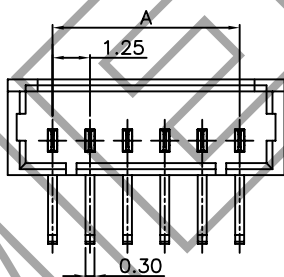

Ordering Information & Dimensions

PART NO.	Dimensions	
	A	B
A1251WR-02P	1.25	4.25
A1251WR-03P	2.50	5.50
A1251WR-04P	3.75	6.75
A1251WR-05P	5.00	8.00
A1251WR-06P	6.25	9.25
A1251WR-07P	7.50	10.50
A1251WR-08P	8.75	11.75
A1251WR-09P	10.00	13.00
A1251WR-10P	11.25	14.25
A1251WR-11P	12.50	15.50
A1251WR-12P	13.75	16.75
A1251WR-13P	15.00	18.00
A1251WR-14P	16.25	19.25
A1251WR-15P	17.50	20.50
A1251WR-16P	18.75	21.75
A1251WR-17P	20.00	23.00
A1251WR-18P	21.25	24.25

Unit: mm

A1251WVA — 1.25mm pitch 180° Wafer

Reference Informations:

- *Material: Pin: Phosphor Bronze/Tin-plated
Wafer: Nylon 66,UL94V-2
- *Mates with E.N A1251 series Housing

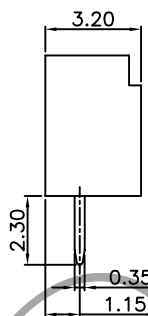
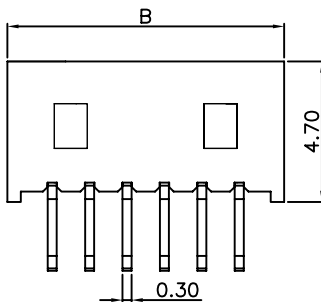
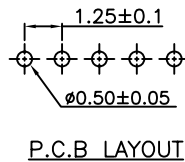
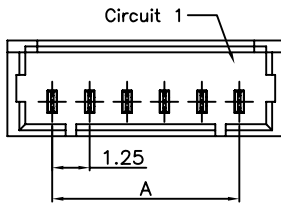
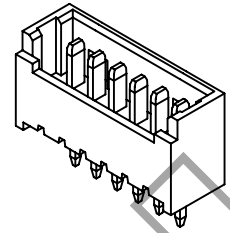

Ordering Information & Dimensions

PART NO.	Dimensions	
	A	B
A1251WVA-02P	1.25	4.25
A1251WVA-03P	2.50	5.50
A1251WVA-04P	3.75	6.75
A1251WVA-05P	5.00	8.00
A1251WVA-06P	6.25	9.25
A1251WVA-07P	7.50	10.50
A1251WVA-08P	8.75	11.75
A1251WVA-09P	10.00	13.00
A1251WVA-10P	11.25	14.25
A1251WVA-11P	12.50	15.50
A1251WVA-12P	13.75	16.75
A1251WVA-13P	15.00	18.00
A1251WVA-14P	16.25	19.25
A1251WVA-15P	17.50	20.50
A1251WVA-16P	18.75	21.75
A1251WVA-17P	20.00	23.00
A1251WVA-18P	21.25	24.25

Unit: mm

A1251WRA — 1.25mm pitch 90° Wafer

Reference Informations:

- *Material: Pin: Phosphor Bronze/Tin-plated
Wafer: Nylon 66,UL94V-2
- *Mates with E.N A1251 series Housing

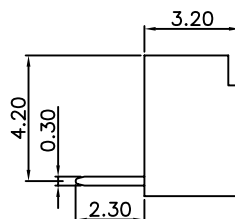
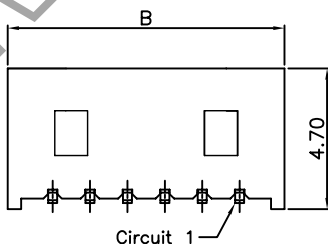
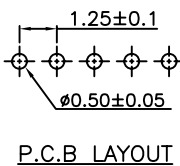
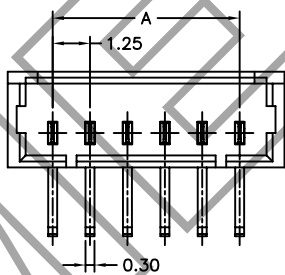
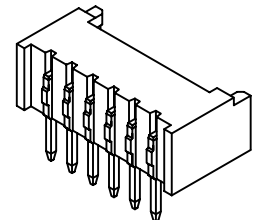

Ordering Information & Dimensions

PART NO.	Dimensions	
	A	B
A1251WRA-02P	1.25	4.25
A1251WRA-03P	2.50	5.50
A1251WRA-04P	3.75	6.75
A1251WRA-05P	5.00	8.00
A1251WRA-06P	6.25	9.25
A1251WRA-07P	7.50	10.50
A1251WRA-08P	8.75	11.75
A1251WRA-09P	10.00	13.00
A1251WRA-10P	11.25	14.25
A1251WRA-11P	12.50	15.50
A1251WRA-12P	13.75	16.75
A1251WRA-13P	15.00	18.00
A1251WRA-14P	16.25	19.25
A1251WRA-15P	17.50	20.50
A1251WRA-16P	18.75	21.75
A1251WRA-17P	20.00	23.00
A1251WRA-18P	21.25	24.25

Unit: mm

A1251WV-S — 1.25mm pitch 180° Wafer — SMT TYPE

Reference Informations:

- *Material: Pin: Brass/Tin-plated
Solder Tabs: Brass/Tin-plated
Wafer: LCP,UL94V-0
- *Mates with E.N A1251 series Housing

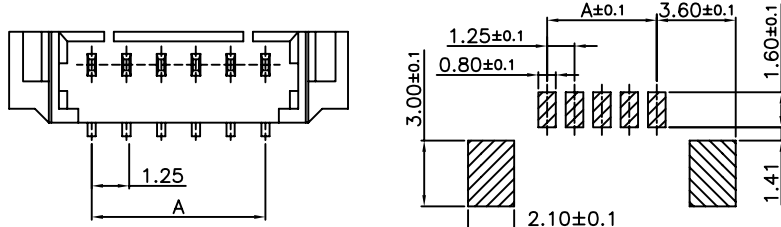
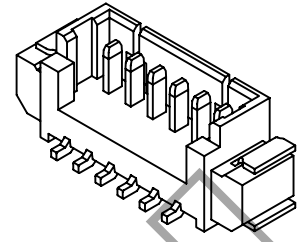

P.C.B LAYOUT

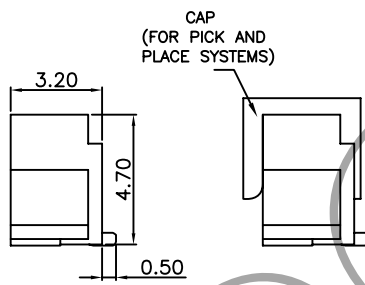
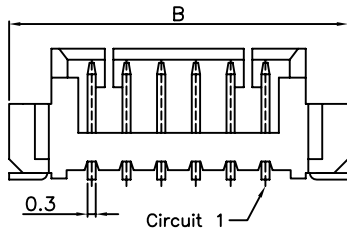

Ordering Information & Dimensions

PART NO.	Dimensions	
	A	B
A1251WV-S-02P	1.25	7.35
A1251WV-S-03P	2.50	8.60
A1251WV-S-04P	3.75	9.85
A1251WV-S-05P	5.00	11.10
A1251WV-S-06P	6.25	12.35
A1251WV-S-07P	7.50	13.60
A1251WV-S-08P	8.75	14.85
A1251WV-S-09P	10.00	16.10
A1251WV-S-10P	11.25	17.35
A1251WV-S-11P	12.50	18.60
A1251WV-S-12P	13.75	19.85
A1251WV-S-13P	15.00	21.10
A1251WV-S-14P	16.25	22.35
A1251WV-S-15P	17.50	23.60
A1251WV-S-16P	18.75	24.95
A1251WV-S-17P	20.00	26.30
A1251WV-S-18P	21.25	27.65

Unit: mm

A1251WR-S — 1.25mm pitch 90° Wafer — SMT TYPE

- *Material: Pin: Brass/Tin-plated
Solder Tabs: Brass/Tin-plated
Wafer: LCP,UL94V-0
- *Mates with E.N A1251 series Housing

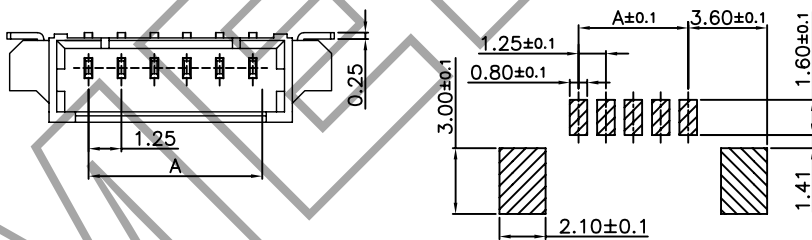
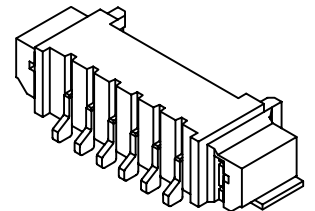

P.C.B LAYOUT

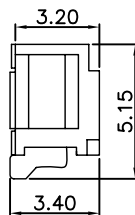
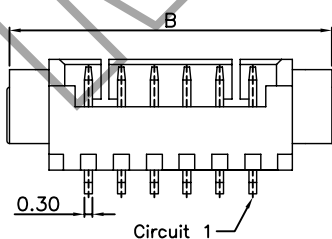

Ordering Information & Dimensions

PART NO.	Dimensions	
	A	B
A1251WR-S-02P	1.25	7.35
A1251WR-S-03P	2.50	8.60
A1251WR-S-04P	3.75	9.85
A1251WR-S-05P	5.00	11.10
A1251WR-S-06P	6.25	12.35
A1251WR-S-07P	7.50	13.60
A1251WR-S-08P	8.75	14.85
A1251WR-S-09P	10.00	16.10
A1251WR-S-10P	11.25	17.35
A1251WR-S-11P	12.50	18.60
A1251WR-S-12P	13.75	19.85
A1251WR-S-13P	15.00	21.10
A1251WR-S-14P	16.25	22.35
A1251WR-S-15P	17.50	23.60
A1251WR-S-16P	18.75	24.95
A1251WR-S-17P	20.00	26.30
A1251WR-S-18P	21.25	27.65

Unit: mm